

IF YOU CHOOSE THIS YOU CHOOSE THE BEST



***PRF PROFILE***

## UPVC CASEMENT WINDOW



### FEATURES

- ▶ **FRAME TYPE :**  
P60-KD CASEMENT WINDOW  
FRAME (60\*58)
- ▶ **SASH TYPE :**  
P60-WKS CASEMENT OUTWARD  
SASH (60\*78)
- ▶ **HARDWARE :**
  - » ESPAG WITH HANDLE LOCK &  
FLAT HINGES
  - » 5 MM CLEAR GLASS
  - » REINFORCEMENT 1 MM &  
ALL ACCESSORIES

## PRF GROUP HARDWARE



## PRF GROUP FOAM FURNITURE



SOFT FOAM MATTRESS



MEMORY FOAM PILLOW

## SLIDING 60 SERIES

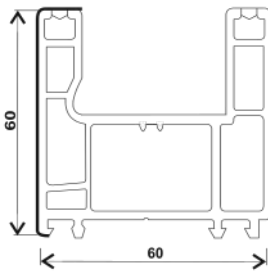

**T60-K, SLIDING 2 TRACK FRAME (60\*60)**

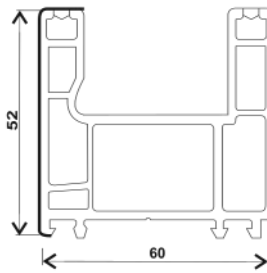

**T60-KB, SLIDING 2 TRACK FRAME (60\*52)**

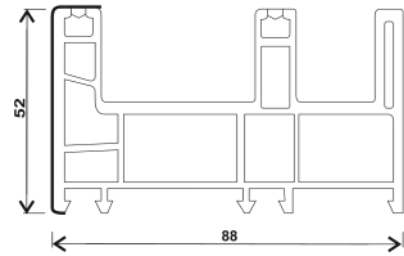

**T88-PK(J), SLIDING 2.5 TRACK FRAME (88\*52)**

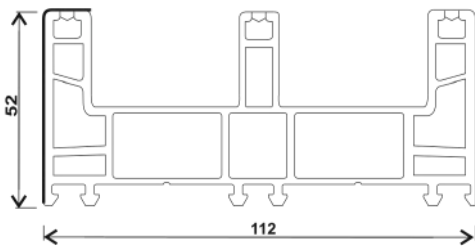

**T112-K, SLIDING 3 TRACK FRAME (112\*52)**

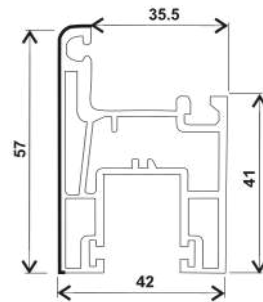

**T88-S, SASH SLIDING WINDOW (42\*57)**

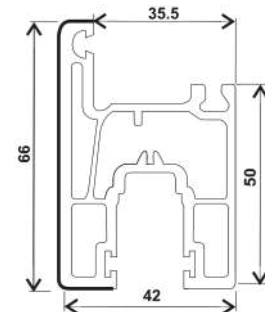

**T95-S, SASH SLIDING WINDOW (42\*66)**

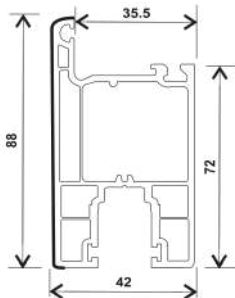

**T-MS, SLIDING DOOR SASH (42\*88)**

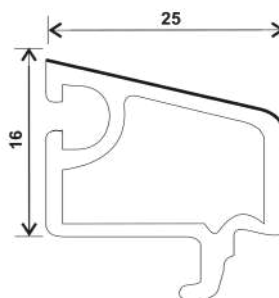

**T88-DY, SLIDING SINGLE GLASS BEAD (16\*25)**

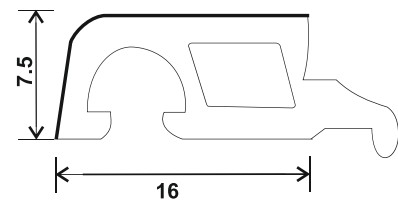

**T88-SY(I), SLIDING DOUBLE GLASS BEAD (SMALL) (16\*7.5)**

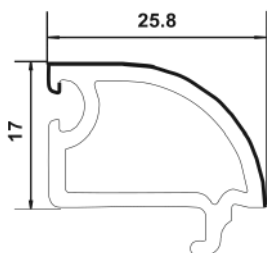

**P70-SY, SLIDING SINGLE GLASS BEAD (17\*25.8)**

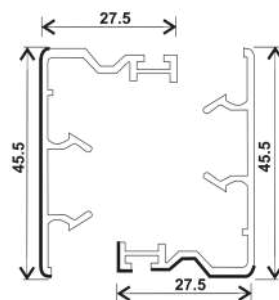

**T88-FBB(I), INTERLOCK WINDOW SASH (27.5\*45.5)**

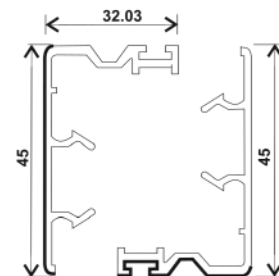

**T95-FB, INTERLOCK WINDOW SASH (32.03\*45)**

## SLIDING 60 SERIES

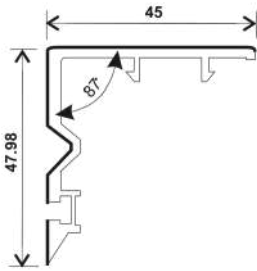

**T-MFB(I), INTERLOCK DOOR (45\*48)**

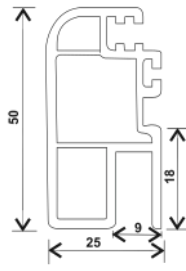

**T80-88-DSS, SASH FLY MESH PROFILE**

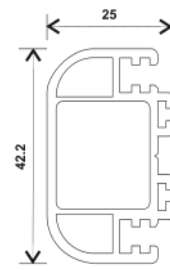

**T80-88-SST, MULLION FLY SASH**

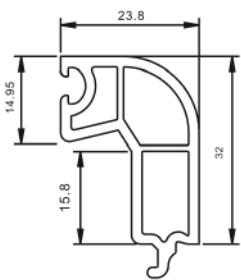

**P70-KSY, SLIDING SINGLE GLASS BEAD (32\*23.8)**

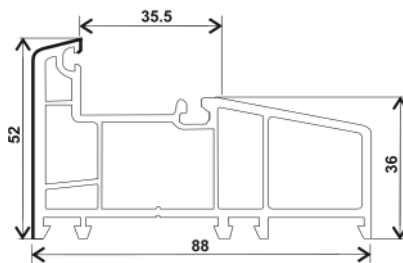

**T88-GDK(B2), SLIDING 2.5 TRACK FIXED FRAME**

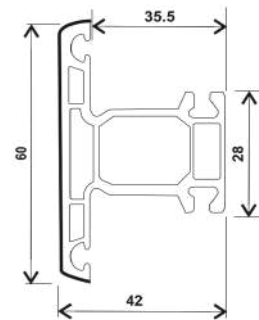

**T88-ST, MULLION T SMALL**

## SLIDING 80 SERIES

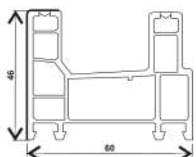

**CF-T60-LGK, SLIDING 2 TRACK FRAME (60\*46)**

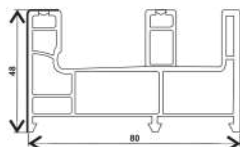

**CF-T80-PK(I), SLIDING 2.5 TRACK FRAME (80\*48)**

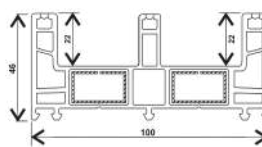

**T100-K, SLIDING 3 TRACK FRAME (100\*46)**

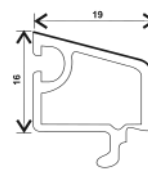

**T80-DY, SLIDING SINGLE GLASS BEAD (16\*19)**

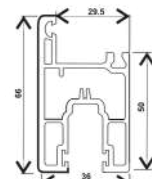

**T80-DS(I), SASH MONORAIL SLIDING (36\*66)**

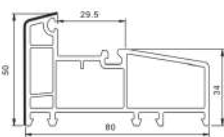

**T80-GDK, SLIDING 2.5 TRACK FIXED FRAME**

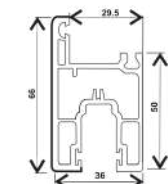

**T80-DS(I), SASH SLIDING WINDOW (36\*66)**

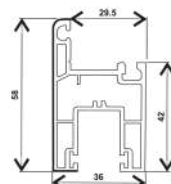

**CF-T60-S, SASH SLIDING WINDOW (36\*58)**

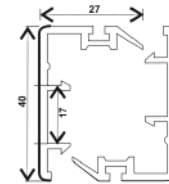

**T80-FBB(I), INTERLOCK WINDOW (27\*40)**

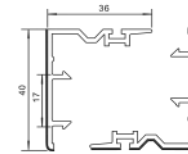

**T80-DFB, INTERLOCK WINDOW (36\*40)**

## CASEMENT WINDOW SERIES

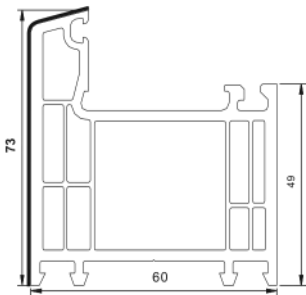

**P60 K(A1)-D, FRAME CASEMENT DOOR (73\*60)**

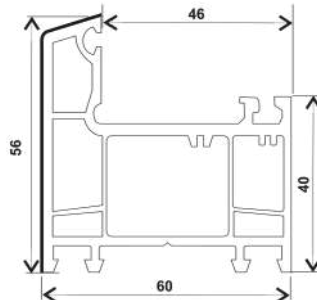

**P60 KD, FRAME CASEMENT WINDOW (60\*58)**

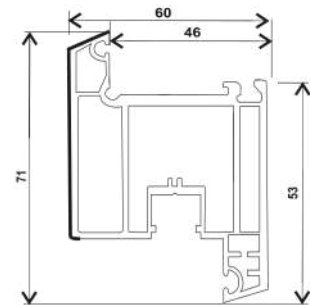

**P60 NKS, SASH WINDOW INWARD (60\*71)**

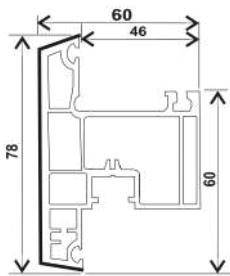

**P60-WKS, SASH WINDOW OUTWARD (60\*78)**

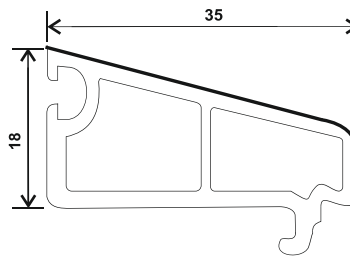

**P60-DY, BEAD CASEMENT SINGLE GLASS (18\*35)**

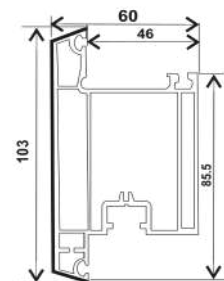

**P60-MS, SASH CASEMENT OUTWARD DOOR (60\*103)**

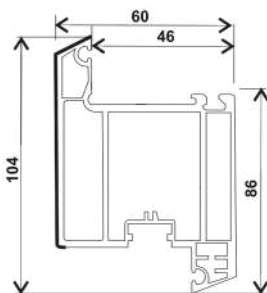

**P60-NKMS, SASH CASEMENT INWARD DOOR (60\*104)**

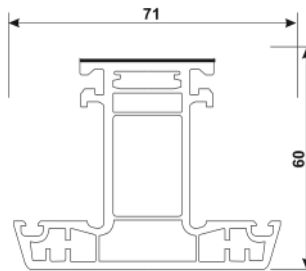

**P60-ZT-D, MULLION T CASEMENT (60\*71)**

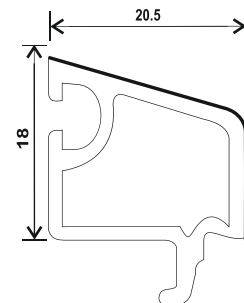

**P60-SY, BEAD DOUBLE GLASS CASEMENT (18\*20.5)**

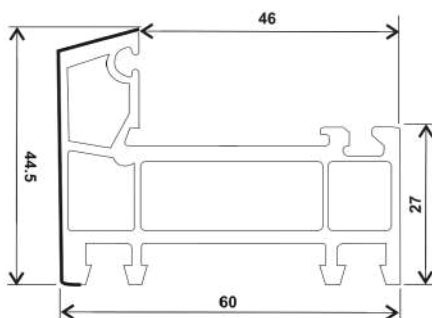

**P60-GDK, FRAME CASEMENT NARROW (60\*44.5)**

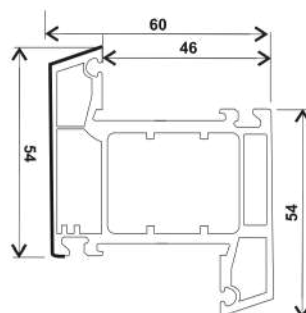

**P60-ZZT(B), MULLION CASEMENT Z**

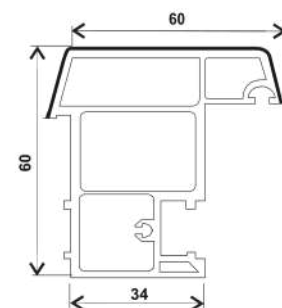

**P60-FZT(II)-D, MULLION CASEMENT MOVABLE (60\*60)**

## ACCESSORIES PROFILE

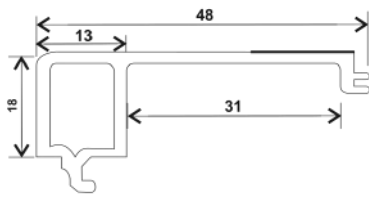

**F-BYYT, LUWAR  
LEFT RIGHT PUNCH\_TOP BOTTOM**

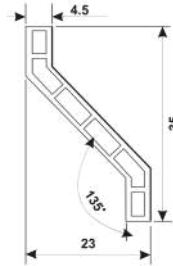

**P-BYP, LUWAR BLADE**

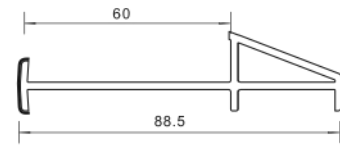

**6F60-80-PB,  
COUPLING 2.5 TRACK**

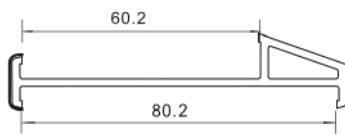

**F60-80-PB,  
COUPLING 2.5 TRACK ECO**

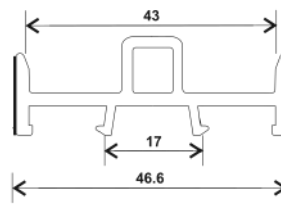

**T88-SSLJ,  
ADAPTOR INLINE 62MM**

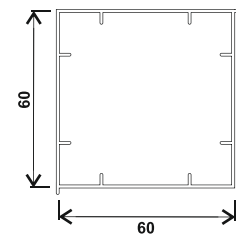

**F60-ZJ,  
ADAPTER SQUARE POST**

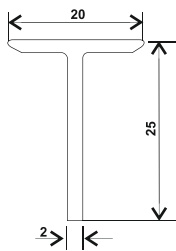

**F-TPT, COUPLING**

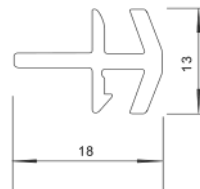

**F-GMT, COUPLING  
SMALL ONE SIDED**

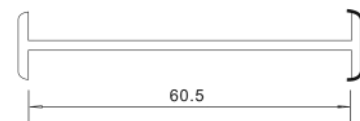

**F60-PB, SMALL  
COUPLING BOTH SIDE**

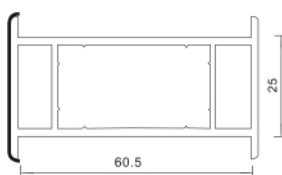

**F60-PG,  
COUPLING BIG**



**F-YG, ADAPTOR  
ROUND POST 62MM**

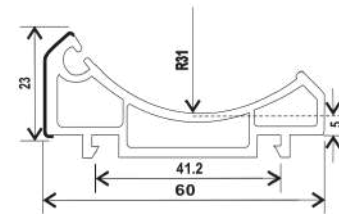

**F-WXZJ, ADAPTOR  
BAY POST 62MM**

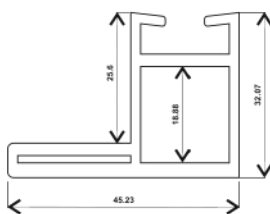

**F-SSG  
ADDON FRAME**

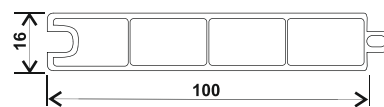

**P50-MB(1), DOOR PANEL**

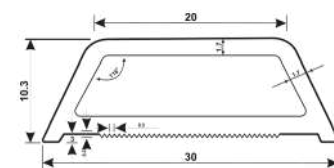

**G-B  
GEORGIAN BAR**



# PRF GROUP

## Our Warehouse

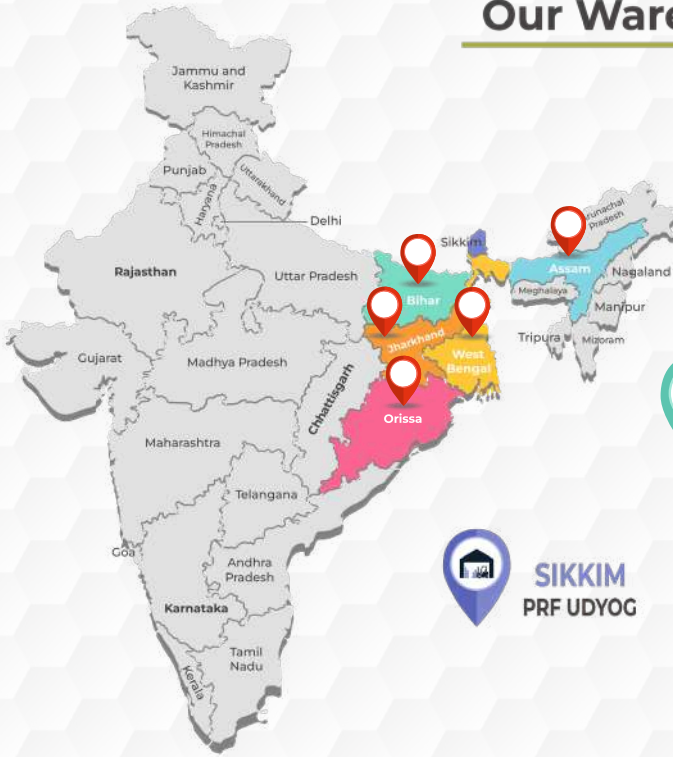

**WEST BENGAL**  
MOTHER WAREHOUSE



**BIHAR**



**ODISHA**



**SIKKIM**  
PRF UDYOG



**JHARKHAND**  
PRF UDYOG



**ASSAM (GUWAHATI)**  
PRF UDYOG

## > CONTACT US

+91 933 093 6298 (OFFICE)  
+91 810 079 8307 (MARKETING)  
+91 810 079 8301 (MARKETING)  
+91 810 079 8324 (MARKETING)

prfudyog.alampur@gmail.com

www.prfudyog.com

Follow us @ Prf Udyog Kolkata

Dhulagarh, P.O- Dhulagarh, Sibtala  
(near Ambuja Cement Industry)  
Kolkata, Howrah, Pincode: 711302



SCAN HERE  
TO GET MORE  
INFORMATION





# • P R F G R O U P •

## SIKKIM PLANT PUF PANEL MANUFACTURING

• GOLD ROOM AND STORAGE ROOFING •

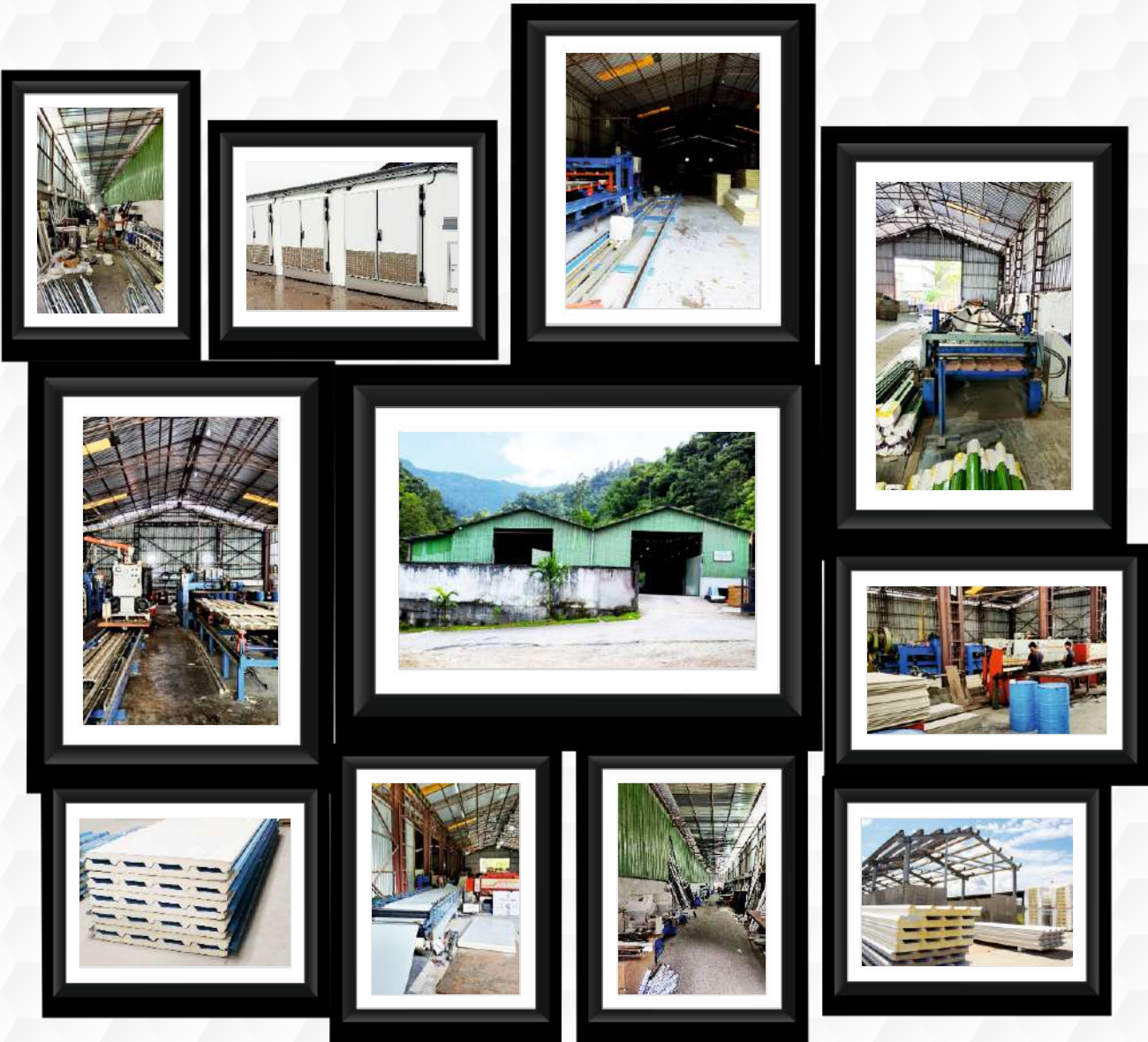

Call us  
☎ +91 933 093 6298  
☎ +91 810 079 8307



Mail Us  
✉ [prfudyog.alampur@gmail.com](mailto:prfudyog.alampur@gmail.com)



Visit Us  
🌐 [www.prfudyog.co.in](http://www.prfudyog.co.in)



Office :  
Amalay, Daring Block,  
Lower Tarku, Tarku,  
South Sikkim - 737 134

Contact us!



Follow us  
@ Prf Udyog Kolkata

