



P R F G R O U P

UPGRADE TO QUALITY. CHOOSE PRF UDYOG.



RUNNER UP UPVC PROFILE

Call us

+91 933 093 6298

More info

prfudyog.alampur@gmail.com

HARDWARES



Touch Lock



Popup Handle



Cocksper Handle



D Handle Large



Bearing Single Roller



Double Roller



Mesh Roller



Single Roller



Adjustable Roller



3D Hinges



2D Hinges



Hinges Concealed

HARDWARES



Plastic Bomb Stopper



Plastic U-Packer



Fix Luwar



Glass Packer



Anti Lift Block



Drainage Cap



Luwar Adjustable Blade



Fastner Screw 8x80



T-Lock



Wool Pile



Gasket



Silicon



Casement Clip



Friction Stay

REINFORCEMENT

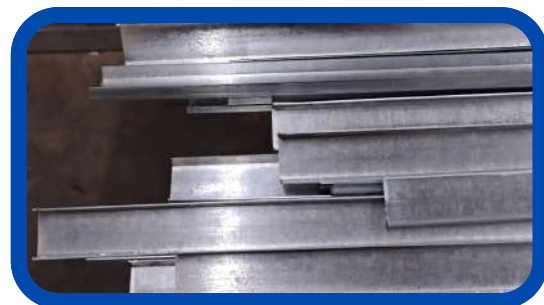

SLIDING 60 SERIES

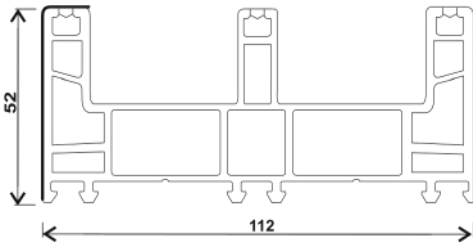

**R T112-K, SLIDING 3 TRACK
FRAME (112*52)**
1.653

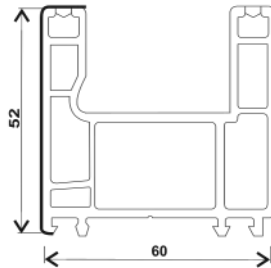

**R T60-KB, SLIDING 2 TRACK
FRAME (60*52)**
1.025

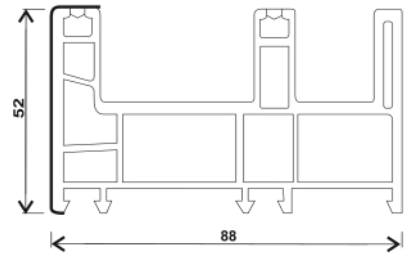

**R T88-PK(J), SLIDING 2.5 TRACK
FRAME (88*52)**
1.322

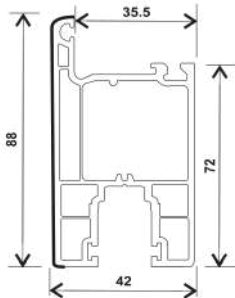

**R T-MS, SLIDING DOOR
SASH (42*88)**
1.193

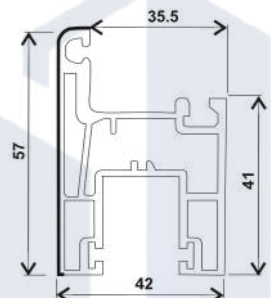

**R T88-S, SASH SLIDING
WINDOW (42*57)**
0.847

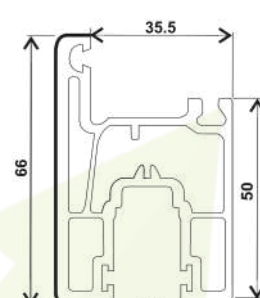

**R T95-S, SASH SLIDING
WINDOW (42*66)**
0.956

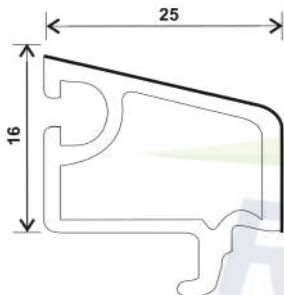

**R T88-DY, SLIDING SINGLE GLASS
BEAD (16*25)**
0.269

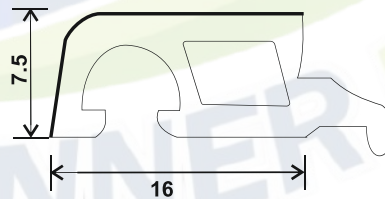

**R T88-SY(I), SLIDING DOUBLE GLASS
BEAD (SMALL)(16*7.5)**

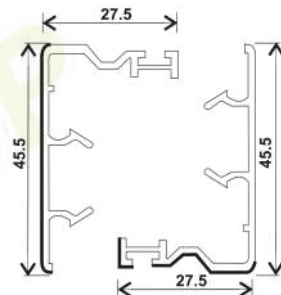

**R T88-FBB(I), INTERLOCK WINDOW
(27.5*42.5)**
0.222

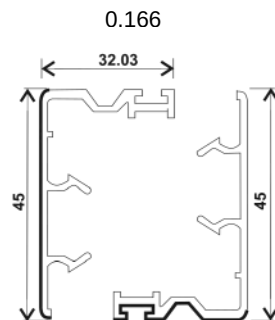

**R T95-FB, INTERLOCK WINDOW
SASH**
0.242

SLIDING 60 SERIES

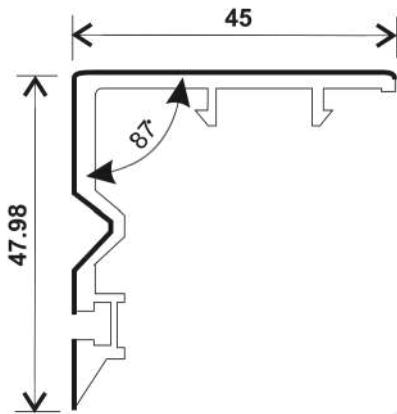

R T-MFB(1), INTERLOCK DOOR (45*48)

0.271

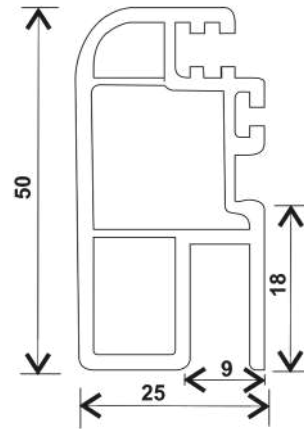

R T80-BB-DSS, SASH FLY MESH PROFILE

0.465

SLIDING ECO SERIES

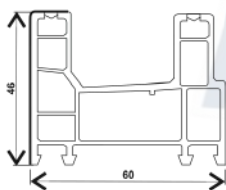

R CF-T60-LGK, SLIDING 2 TRACK FRAME (60*46)

0.939

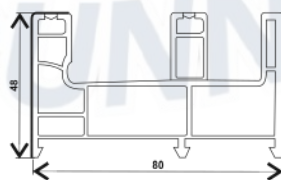

R CF-T80-PK(I), SLIDING 2.5 TRACK FRAME (80*48)

1.176

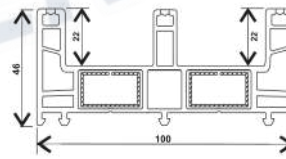

R T100-K, SLIDING 3 TRACK FRAME (100*48)

1.445

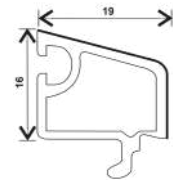

R T80-DY, SLIDING GLASS BEAD (16*19)

0.227

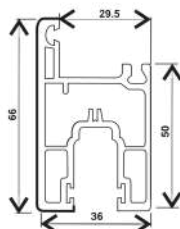

R T80-DS(I), SASH MONORAIL SLIDING (36*66)

0.893

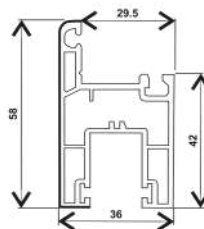

R CF-T60-S, SASH SLIDING WINDOW (36*58)

0.786

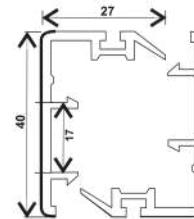

R T80-FBB(I), INTERLOCK WINDOW (27*40)

0.212

CASEMENT WINDOW SERIES

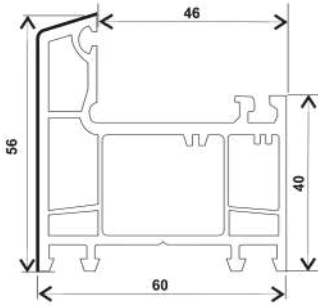

R P60 KD, FRAME CASEMENT WINDOW (60*58)
1.043

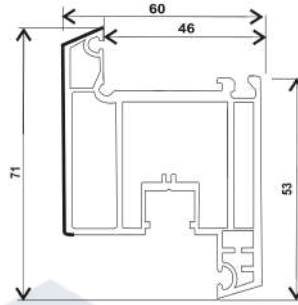

R P60 NKS, SASH WINDOW INWARD (60*71)
1.260

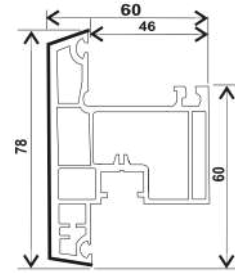

R P60-WKS, SASH WINDOW OUTWARD (60*78)
1.333

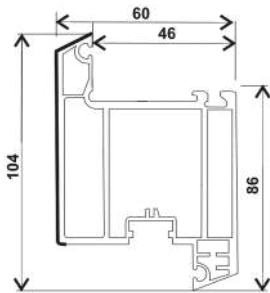

R P60-NKMS, SASH CASEMENT INWARD DOOR (60*104)
1.560

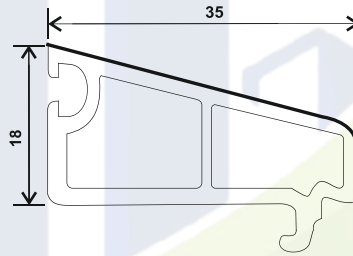

R P60-DY, BEAD CASEMENT SINGLE GLASS (18*35)
0.324

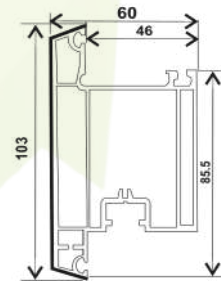

R P60-MS, SASH CASEMENT OUTWARD DOOR (60*103)
1.580

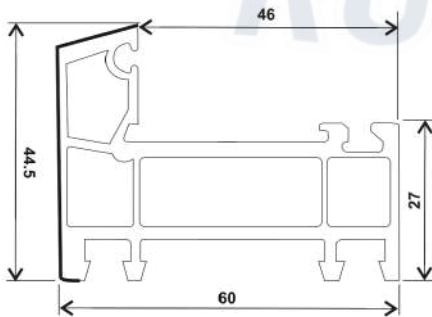

R P60-GDK, FRAME CASEMENT NARROW (60*44.5)
0.801

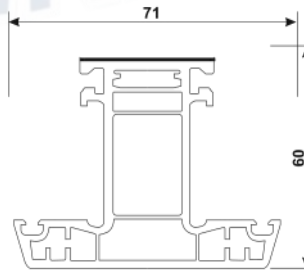

R P60-ZT-D, MULLION T CASEMENT (60*71)
1.198

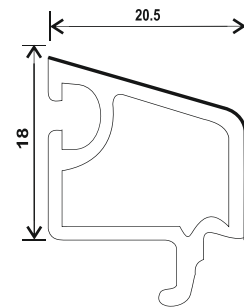

R P60-SY, BEAD DOUBLE GLASS CASEMENT (18*20.5)
0.233



• P R F G R O U P •

PUF PANEL AND REINFORCEMENT MANUFACTURING

PUF ROOFING PANEL



REINFORCEMENT

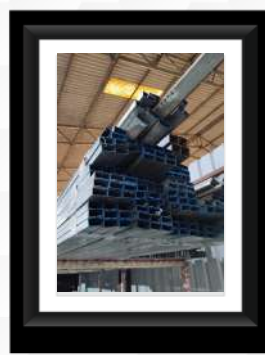



PRF GROUP

Our Warehouse

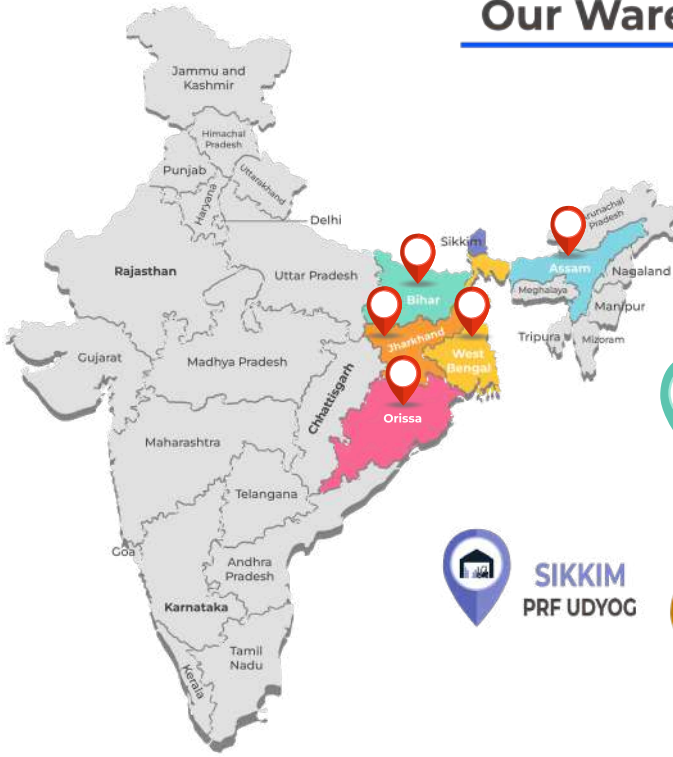

WEST BENGAL
MOTHER WAREHOUSE



BIHAR
PRF UDYOG



ODISHA
PRF UDYOG



SIKKIM
PRF UDYOG



JHARKHAND
PRF UDYOG



ASSAM (GUWAHATI)
PRF UDYOG

CONTACT US

- +91 933 093 6298 (WB OFFICE)
- +91 810 079 8301 (ASSAM OFFICE)
- +91 810 079 8322 (JHARKHAND OFFICE)
- +919147768780 (ODISHA OFFICE)

prfudyog.alampur@gmail.com

www.prfudyog.com

Follow us @ Prf Udyog Kolkata

Dhulagarh, P.O- Dhulagarh, Sibtala
(near Ambuja Cement Industry)
Kolkata, Howrah, Pincode: 711302



SCAN HERE
TO GET MORE
INFORMATION

