

IF YOU CHOOSE THIS YOU CHOOSE THE BEST



***PRF PROFILE***

## UPVC CASEMENT WINDOW



### FEATURES

- ▶ **FRAME TYPE :**  
P60-KD CASEMENT WINDOW  
FRAME (60\*58)
- ▶ **SASH TYPE :**  
P60-WKS CASEMENT OUTWARD  
SASH (60\*78)
- ▶ **HARDWARE :**
  - › ESPAG WITH HANDLE LOCK &  
FLAT HINGES
  - › 5 MM CLEAR GLASS
  - › REINFORCEMENT 1 MM &  
ALL ACCESSORIES

## PRF GROUP HARDWARE



## PRF GROUP FOAM FURNITURE



SOFT FOAM MATTRESS



MEMORY FOAM PILLOW

## SLIDING 60 SERIES

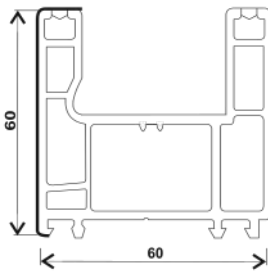

**T60-K, SLIDING 2 TRACK FRAME (60\*60)**

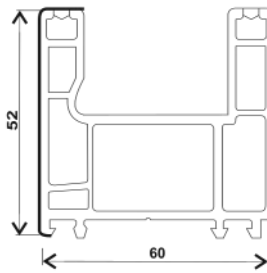

**T60-KB, SLIDING 2 TRACK FRAME (60\*52)**

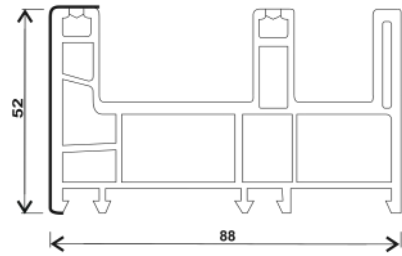

**T88-PK(J), SLIDING 2.5 TRACK FRAME (88\*52)**

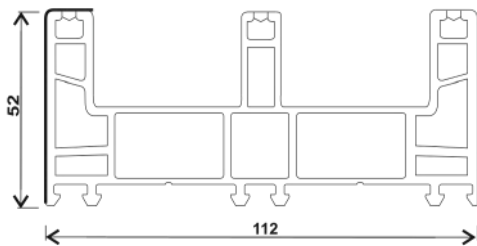

**T112-K, SLIDING 3 TRACK FRAME (112\*52)**

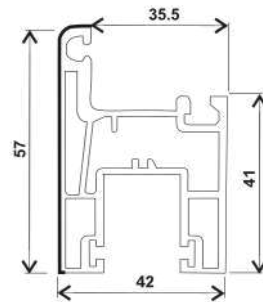

**T88-S, SASH SLIDING WINDOW (42\*57)**

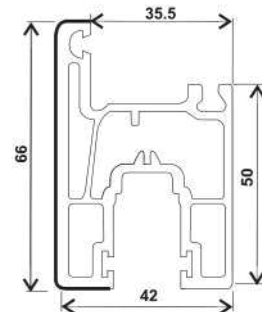

**T95-S, SASH SLIDING WINDOW (42\*66)**

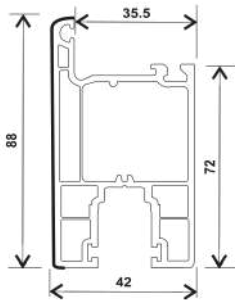

**T-MS, SLIDING DOOR SASH (42\*88)**

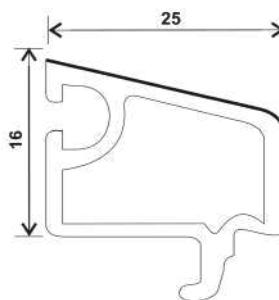

**T88-DY, SLIDING SINGLE GLASS BEAD (16\*25)**

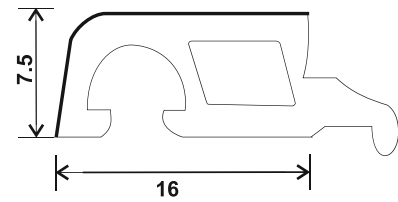

**T88-SY(I), SLIDING DOUBLE GLASS BEAD (SMALL) (16\*7.5)**

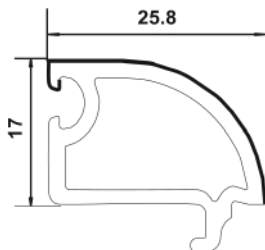

**P70-SY, SLIDING SINGLE GLASS BEAD (17\*25.8)**

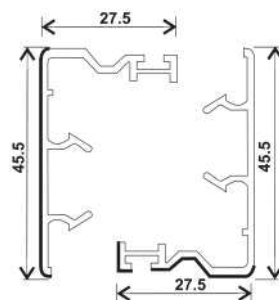

**T88-FBB(I), INTERLOCK WINDOW SASH (27.5\*45.5)**

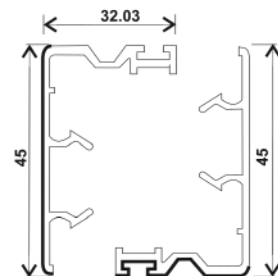

**T95-FB, INTERLOCK WINDOW SASH (32.03\*45)**

## SLIDING 60 SERIES

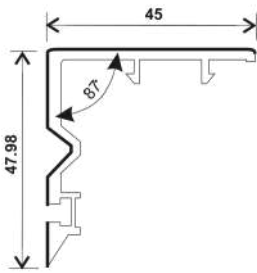

**T-MFB(I), INTERLOCK DOOR (45\*48)**

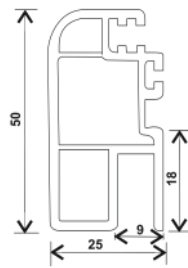

**T80-88-DSS, SASH FLY MESH PROFILE**

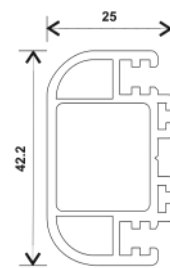

**T80-88-SST, MULLION FLY SASH**

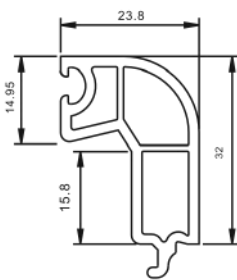

**P70-KSY, SLIDING SINGLE GLASS BEAD (32\*23.8)**

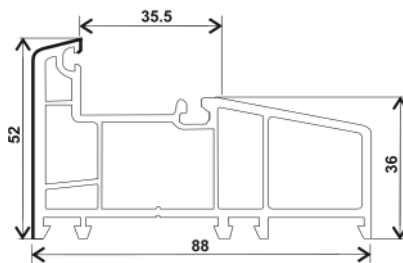

**T88-GDK(B2), SLIDING 2.5 TRACK FIXED FRAME**

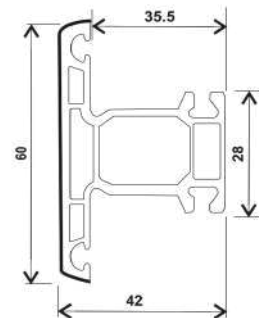

**T88-ST, MULLION T SMALL**

## SLIDING 80 SERIES

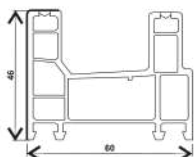

**CF-T60-LGK, SLIDING 2 TRACK FRAME (60\*46)**

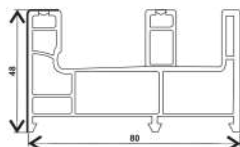

**CF-T80-PK(I), SLIDING 2.5 TRACK FRAME (80\*48)**

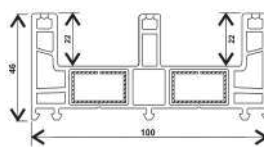

**T100-K, SLIDING 3 TRACK FRAME (100\*46)**

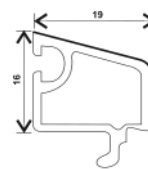

**T80-DY, SLIDING SINGLE GLASS BEAD (16\*19)**

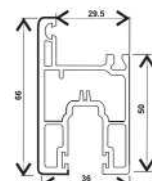

**T80-DS(I), SASH MONORAIL SLIDING (36\*66)**

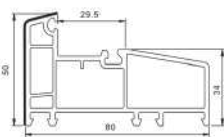

**T80-GDK, SLIDING 2.5 TRACK FIXED FRAME**

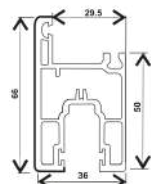

**T80-DS(I), SASH SLIDING WINDOW (36\*66)**

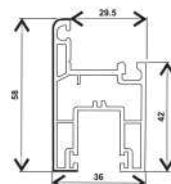

**CF-T60-S, SASH SLIDING WINDOW (36\*58)**

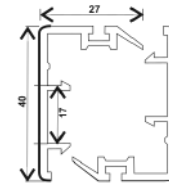

**T80-FBB(I), INTERLOCK WINDOW (27\*40)**

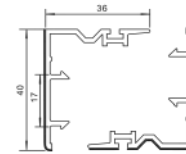

**T80-DFB, INTERLOCK WINDOW (36\*40)**

## CASEMENT WINDOW SERIES

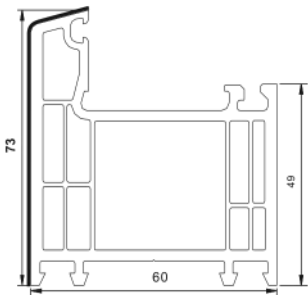

**P60 K(A1)-D, FRAME CASEMENT DOOR (73\*60)**

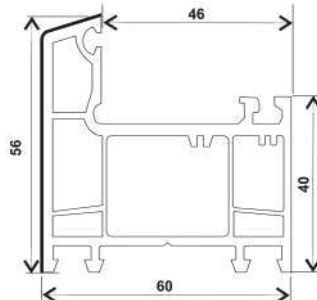

**P60 KD, FRAME CASEMENT WINDOW (60\*58)**

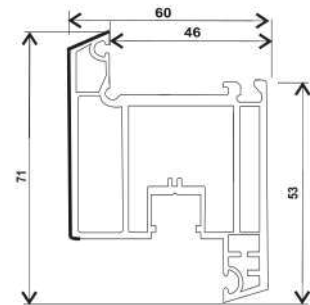

**P60 NKS, SASH WINDOW INWARD (60\*71)**

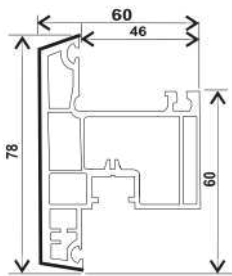

**P60-WKS, SASH WINDOW OUTWARD (60\*78)**

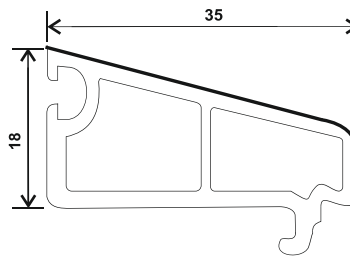

**P60-DY, BEAD CASEMENT SINGLE GLASS (18\*35)**

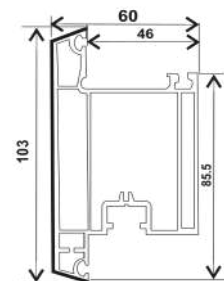

**P60-MS, SASH CASEMENT OUTWARD DOOR (60\*103)**

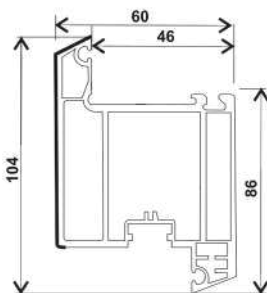

**P60-NKMS, SASH CASEMENT INWARD DOOR (60\*104)**

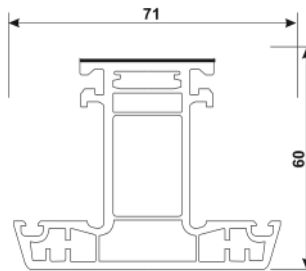

**P60-ZT-D, MULLION T CASEMENT (60\*71)**

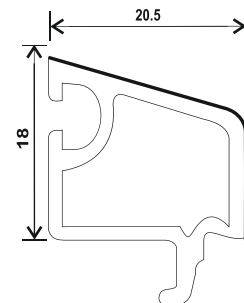

**P60-SY, BEAD DOUBLE GLASS CASEMENT (18\*20.5)**

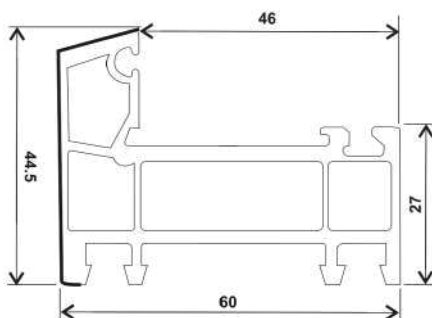

**P60-GDK, FRAME CASEMENT NARROW (60\*44.5)**

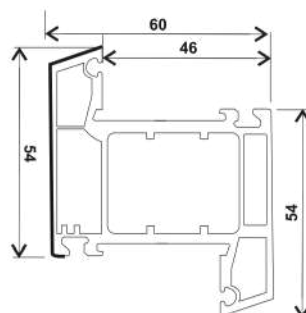

**P60-ZZT(B), MULLION CASEMENT Z**

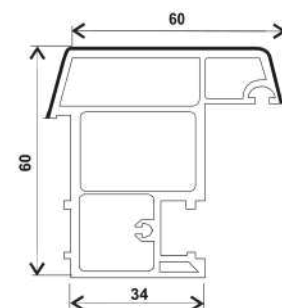

**P60-FZT(II)-D, MULLION CASEMENT MOVABLE (60\*60)**

## ACCESSORIES PROFILE

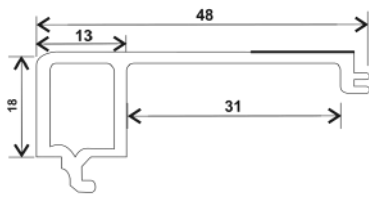

**F-BYYT, LUWAR  
LEFT RIGHT PUNCH\_TOP BOTTOM**

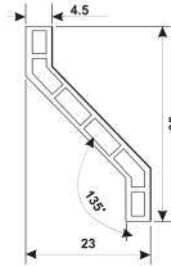

**P-BYP, LUWAR BLADE**

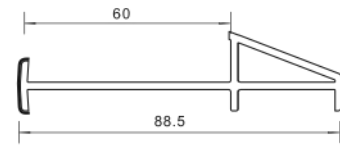

**6F60-80-PB,  
COUPLING 2.5 TRACK**

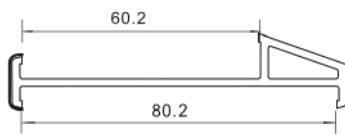

**F60-80-PB,  
COUPLING 2.5 TRACK ECO**

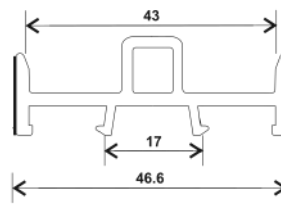

**T88-SSLJ,  
ADAPTOR INLINE 62MM**

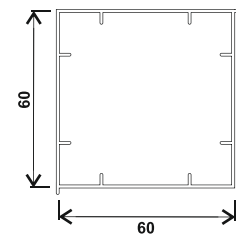

**F60-ZJ,  
ADAPTER SQUARE POST**

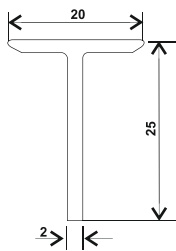

**F-TPT, COUPLING**

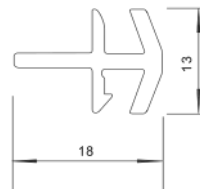

**F-GMT, COUPLING  
SMALL ONE SIDED**

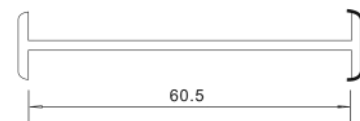

**F60-PB, SMALL  
COUPLING BOTH SIDE**

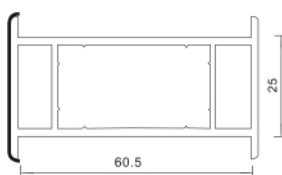

**F60-PG,  
COUPLING BIG**



**F-YG, ADAPTOR  
ROUND POST 62MM**

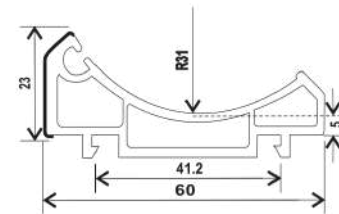

**F-WXZJ, ADAPTOR  
BAY POST 62MM**

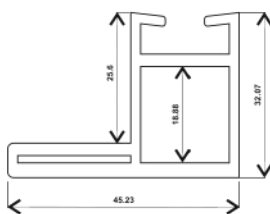

**F-SSG  
ADDON FRAME**

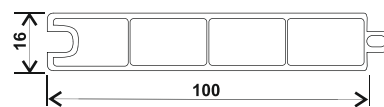

**P50-MB(1), DOOR PANEL**

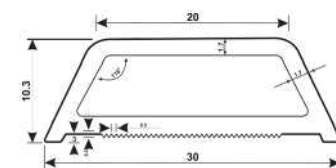

**G-B  
GEORGIAN BAR**



# PRF GROUP

## Our Warehouse

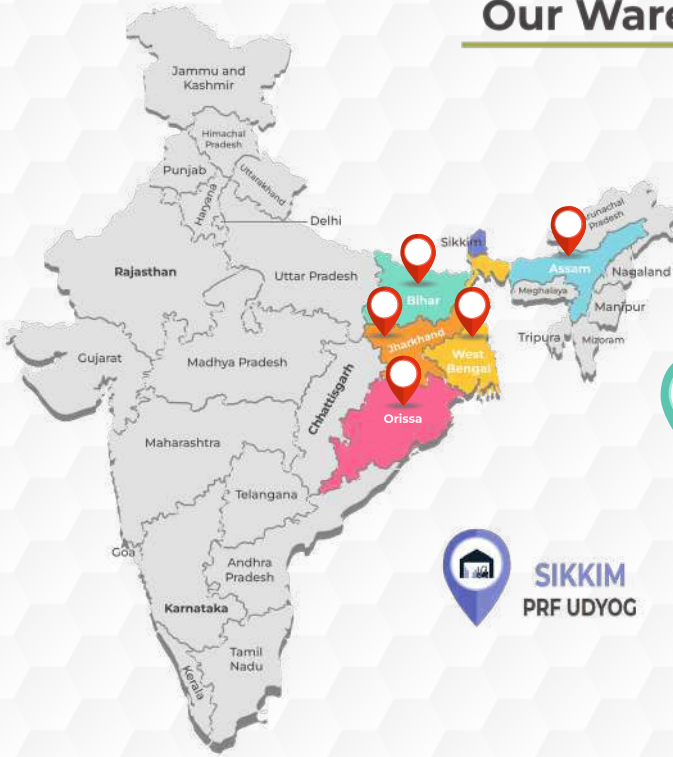

**WEST BENGAL**  
MOTHER WAREHOUSE



**BIHAR**



**ODISHA**



**SIKKIM**  
PRF UDYOG

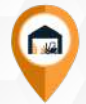

**JHARKHAND**  
PRF UDYOG



**ASSAM (GUWAHATI)**  
PRF UDYOG

## CONTACT US

+91 933 093 6298 (OFFICE)  
+91 810 079 8307 (MARKETING)  
+91 810 079 8301 (MARKETING)  
+91 810 079 8324 (MARKETING)

prfudyog.alampur@gmail.com

www.prfudyog.com

Follow us @ Prf Udyog Kolkata

Dhulagarh, P.O- Dhulagarh, Sibtala  
(near Ambuja Cement Industry)  
Kolkata, Howrah, Pincode: 711302



SCAN HERE  
TO GET MORE  
INFORMATION





# • P R F G R O U P •

## SIKKIM PLANT PUF PANEL MANUFACTURING

• GOLD ROOM AND STORAGE ROOFING •

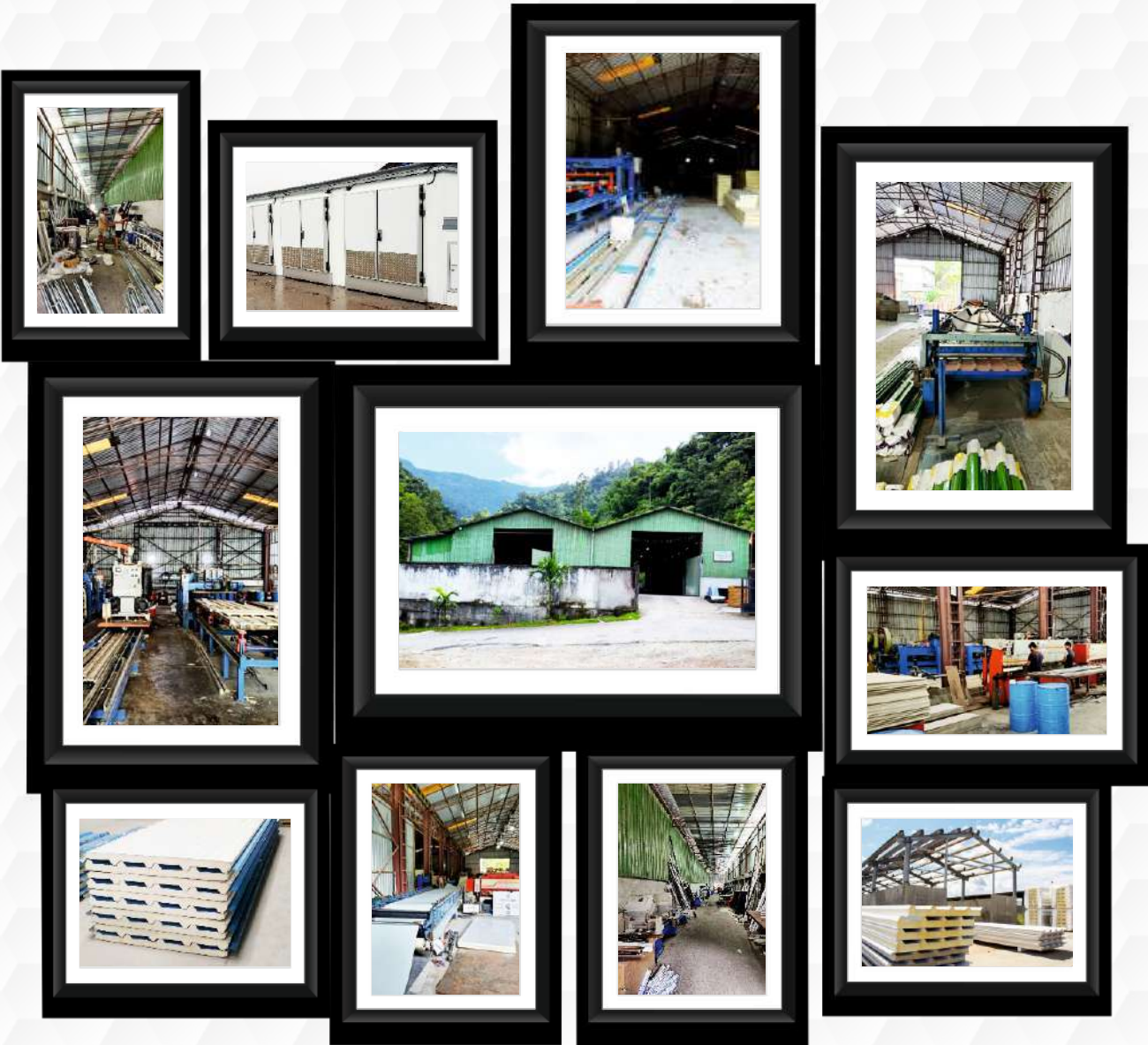

Call us

+91 933 093 6298  
+91 810 079 8307



Mail Us  
prfudyog.alampur@gmail.com



Visit Us  
www.prfudyog.co.in



Office :

Amalay, Daring Block,  
Lower Tarku, Tarku,  
South Sikkim - 737 134

Contact us!



Follow us  
@ Prf Udyog Kolkata



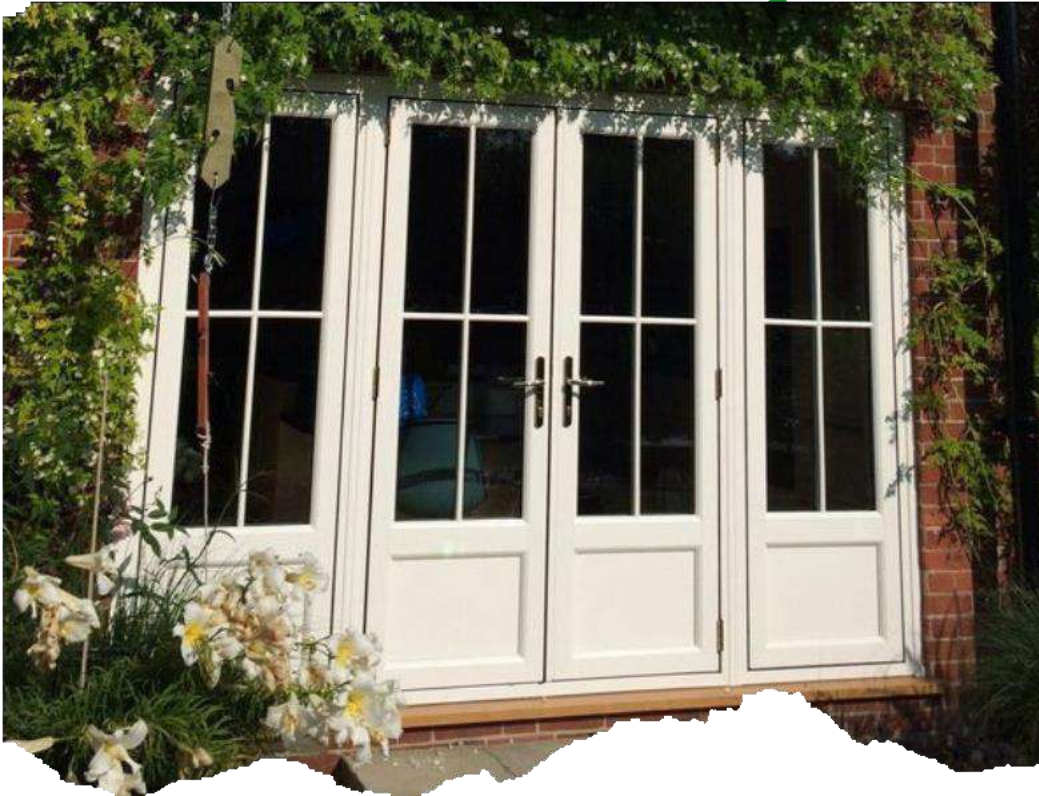

# WIN-ECO uPVC PROFILES



YEAR  
2024



GREMAN TECHNOLOGY  
INDIAN BRAND



**TALK TO US**  
8100798302/8100798312

[www.wineco.in](http://www.wineco.in)



# CREATING FUTURE TOGETHER

[www.wineco.in](http://www.wineco.in)

# SLIDING 60 SERIES

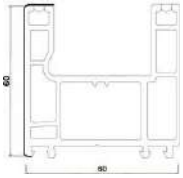

WI-SF-60

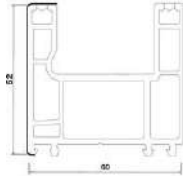

WI-SF-52

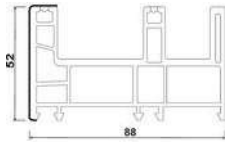

WI-SF-88

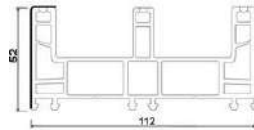

WI-SF-112

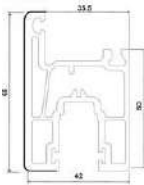

WI-SS-66

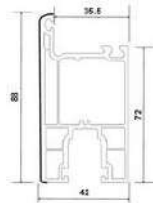

WI-SS-88

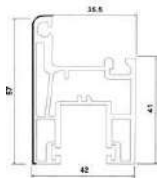

WI-SF-88

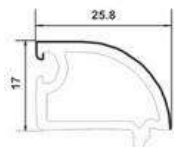

WI-SRB-25

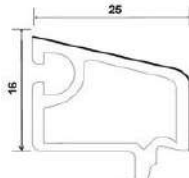

WI-SSB-25

# ACCESSORIES PROFILE

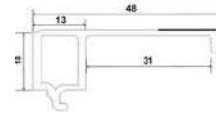

WI-LTB

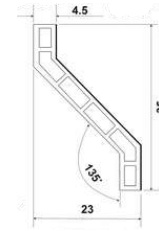

WI-LB

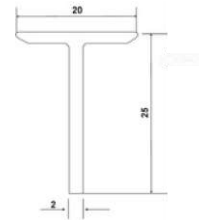

W-ACP-2.5

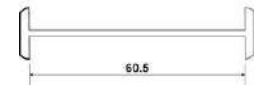

WI-CSBS



WI-ASP

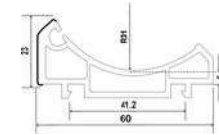

WI-ABP-60

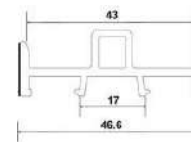

WI-AI-62



WI-ARP-62

# CASEMENT WINDOW SERIES

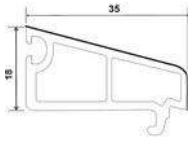

WI-CSB-35

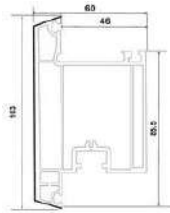

WI-CODS-103

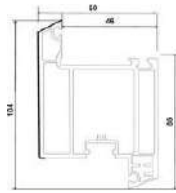

WI-CIDS-104

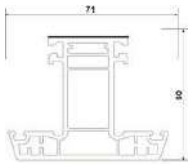

WI-CTM-71



WI-CDB-20.5

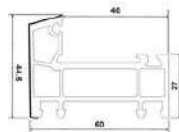

WI-CNF-44.5

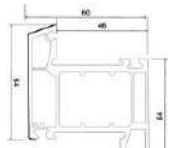

WI-CZM

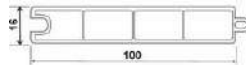

WI-CDP-50

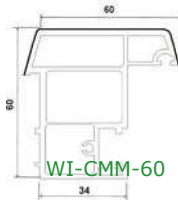

WI-CMM-60

# SLIDING 60 SERIES

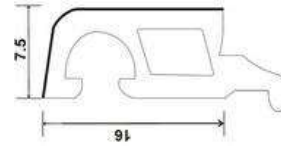

WI-SDB-25

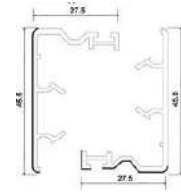

WI-ILW-42.5

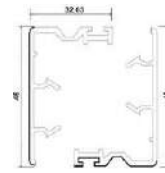

WI-IMW-45

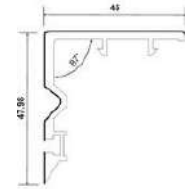

WI-ID-48



WI-MFM



WI-S-FMM

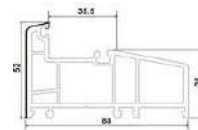

WI-S-FM-FM



WI-MTS

## SLIDING ECO SERIES

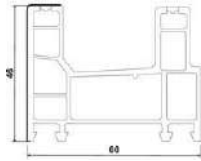

WI-ESF-46

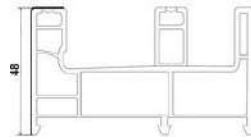

WI-ESF-80

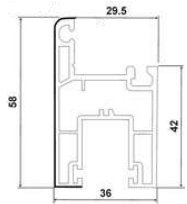

W-ESS-58

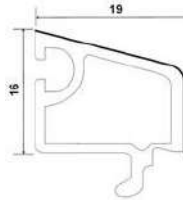

W-ESSB-19

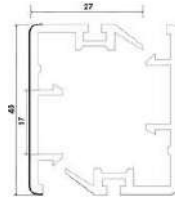

WI-EIW

## SLIDING MONORAIL

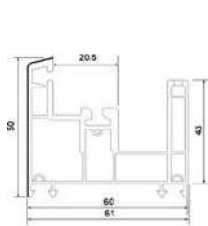

WI-MSF-60

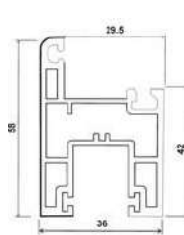

WI-MSS-58

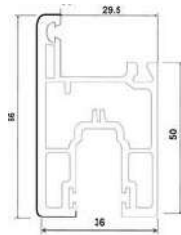

WI-EMS-66

## SLIDING MONORAIL



WI-MM-34.5

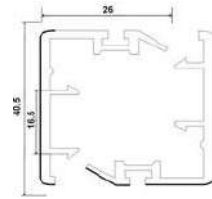

WI-MI-40.5

## CASEMENT WINDOW SERIES

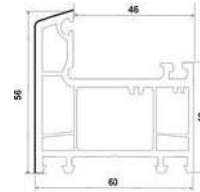

WI-CDF-58

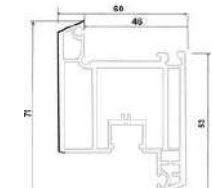

WI-CWIS-71



WI-CTM-71



WI-CDF-73



# PRF GROUP

## Our Warehouse



**WEST BENGAL**  
MOTHER WAREHOUSE



**BIHAR**  
LB ENTERPRISES



**ODISHA**  
LB ENTERPRISES



**SIKKIM**  
PRF UDYOG



**JHARKHAND**  
PRF UDYOG



**ASSAM (GUWAHATI)**  
PRF UDYOG

## CONTACT US

+91 933 093 6298 (OFFICE)  
+91 810 079 8307 (MARKETING)  
+91 810 079 8301 (MARKETING)  
+91 810 079 8324 (MARKETING)

prfudyog.alampur@gmail.com

www.prfudyog.com

Follow us @ Prf Udyog Kolkata

Dhulagarh, P.O- Dhulagarh, Sibtala  
(near Ambuja Cement Industry)  
Kolkata, Howrah, Pincode: 711302



SCAN HERE  
TO GET MORE  
INFORMATION



IF YOU CHOOSE THIS YOU CHOOSE THE BEST



**Z-PLAST UPVC  
PROFILES.**



• P R F G R O U P •

### UPVC CASEMENT WINDOW



#### FEATURES

- ▶ FRAME TYPE :  
P60-KD CASEMENT WINDOW  
FRAME (60\*58)
- ▶ SASH TYPE :  
P60-WKS CASEMENT OUTWARD  
SASH (60\*78)
- ▶ HARDWARE :
  - › ESPAG WITH HANDLE LOCK &  
FLAT HINGES
  - › 5 MM CLEAR GLASS
  - › REINFORCEMENT 1 MM &  
ALL ACCESSORIES

### PRF GROUP HARDWARE



### PRF GROUP FOAM FURNITURE



SOFT FOAM MATTRESS



MEMORY FOAM PILLOW

P2



• P R F G R O U P •

### SIKKIM PLANT PUF PANEL MANUFACTURING

#### • COLD ROOM AND STORAGE ROOFING •



Call us  
 ☎ +91 933 093 6298  
 ☎ +91 810 079 8307



Mail Us  
 prfudyog.alampur@gmail.com



Visit Us  
 www.prfudyog.co.in



Office :  
 Amalay, Daring Block,  
 Lower Tarku, Tarku,  
 South Sikkim - 737 134

#### Contact us!



Follow us  
 @ Prf Udyog Kolkata

**SLIDING 60 SERIES**

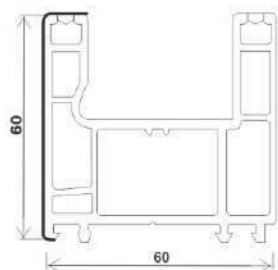

**T60-K, SLIDING 2 TRACK FRAME (60\*60)**

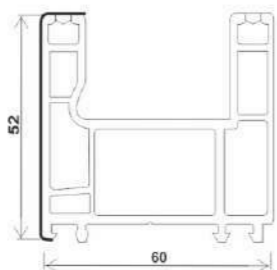

**T60-KB, SLIDING 2 TRACK FRAME (60\*52)**

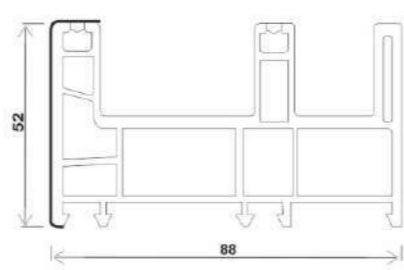

**T88-PK(J), SLIDING 2.5 TRACK FRAME (88\*52)**

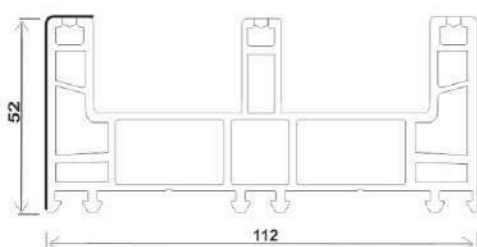

**T112-K, SLIDING 3 TRACK FRAME (112\*52)**

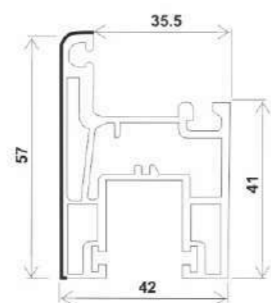

**T88-S, SASH SLIDING WINDOW (42\*57)**

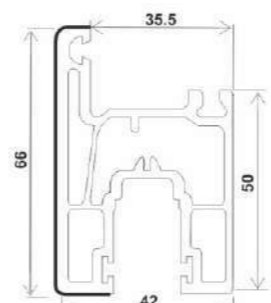

**T95-S, SASH SLIDING WINDOW (42\*66)**

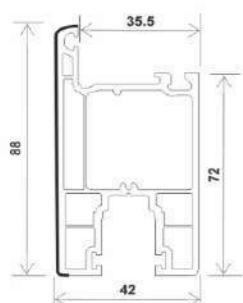

**T-MS, SLIDING DOOR SASH (42\*88)**

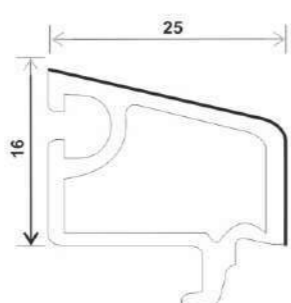

**T88-DY, SLIDING SINGLE GLASS BEAD (16\*25)**

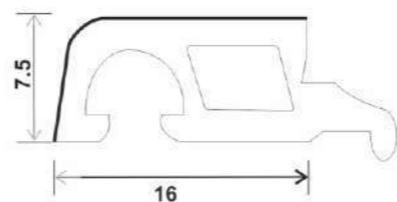

**T88-SY(I), SLIDING DOUBLE GLASS BEAD (SMALL) (16\*7.5)**

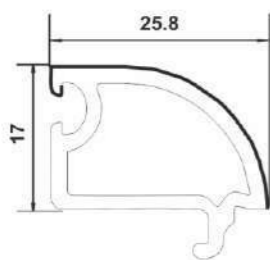

**P70-SY, SLIDING SINGLE GLASS BEAD (17\*25.8)**

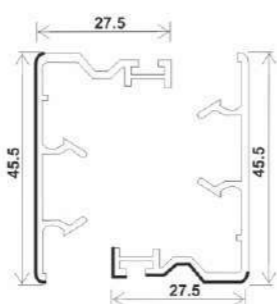

**T88-FBB(I), INTERLOCK WINDOW SASH (27.5\*45.5)**

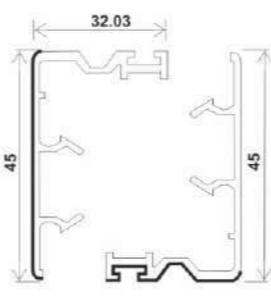

**T95-FB, INTERLOCK WINDOW SASH (32.03\*45)**

**ACCESSORIES PROFILE**

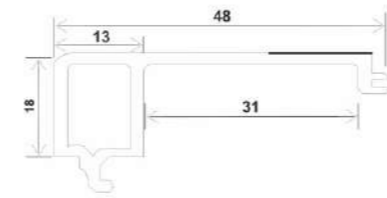

**F-BYYT, LUWAR LEFT RIGHT PUNCH \_TOP BOTTOM**

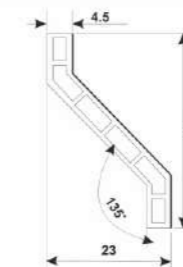

**P-BYP, LUWAR BLADE**

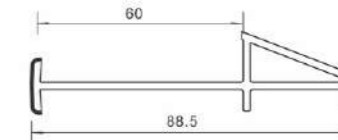

**6F60-80-PB, COUPLING 2.5 TRACK**

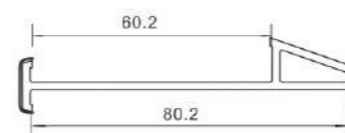

**F60-80-PB, COUPLING 2.5 TRACK ECO**

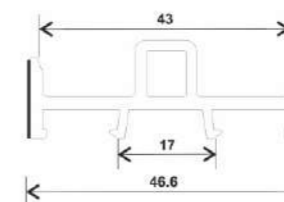

**T88-SSLJ, ADAPTOR INLINE 62MM**

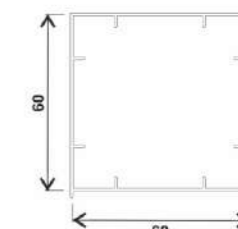

**F60-ZJ, ADAPTER SQUARE POST**

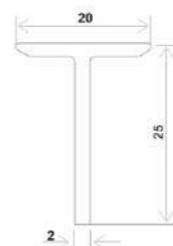

**F-TPT, COUPLING**

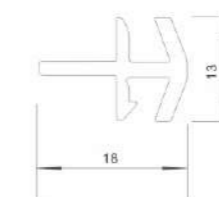

**F-GMT, COUPLING SMALL ONE SIDED**

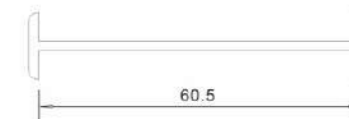

**F60-PB, SMALL COUPLING BOTH SIDE**



**F60-PG, COUPLING BIG**

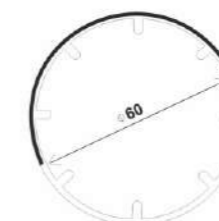

**F-YG, ADAPTOR ROUND POST 62MM**

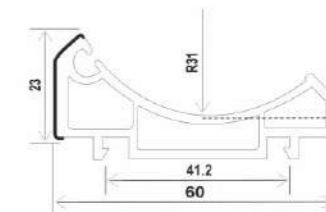

**F-WXZJ, ADAPTOR BAY POST 62MM**

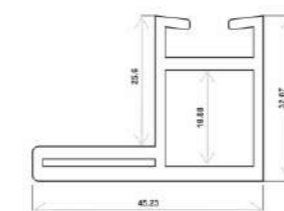

**F-SSG ADDON FRAME**

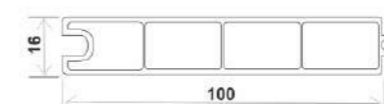

**P50-MB(1), DOOR PANEL**

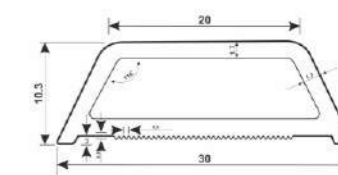

**G-B GEORGIAN BAR**

**SLIDING 60 SERIES**

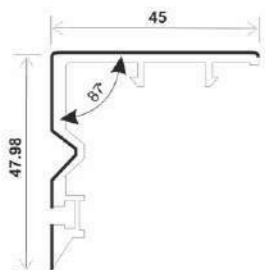

**T-MFB(1), INTERLOCK DOOR (45\*48)**

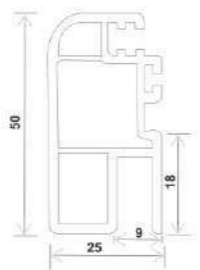

**T80-88-DSS, SASH FLY MESH PROFILE**

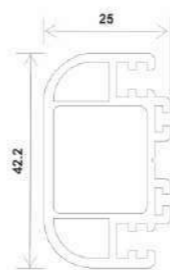

**T80-88-SST, MULLION FLY SASH**

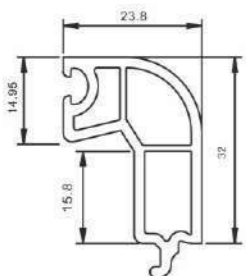

**P70-KSY, SLIDING SINGLE GLASS BEAD (32\*23.8)**

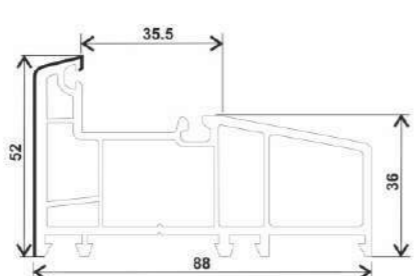

**T88-GDK(B2), SLIDING 2.5 TRACK FIXED FRAME**

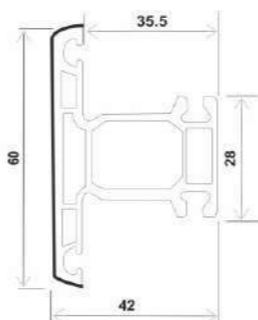

**T88-ST, MULLION T SMALL**

**SLIDING 80 SERIES**

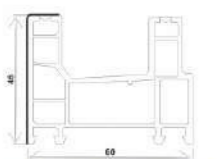

**CF-T60-LGK, SLIDING 2 TRACK FRAME (60\*46)**

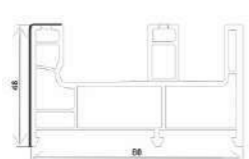

**CF-T80-PK(I), SLIDING 2.5 TRACK FRAME (80\*48)**

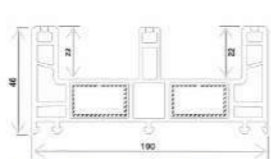

**T100-K, SLIDING 3 TRACK FRAME (100\*46)**



**T80-DY, SLIDING SINGLE GLASS BEAD (16\*19)**

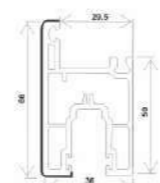

**T80-DS(I), SASH MONORAIL SLIDING (36\*66)**

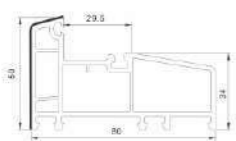

**T80-GDK, SLIDING 2.5 TRACK FIXED FRAME**

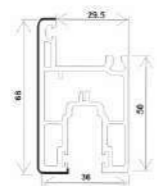

**T80-DS(II), SASH SLIDING WINDOW (36\*66)**



**CF-T60-S, SASH SLIDING WINDOW (36\*58)**

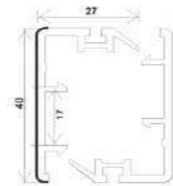

**T80-FBB(I), INTERLOCK WINDOW (27\*40)**

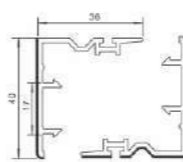

**T80-DFB, INTERLOCK WINDOW (36\*40)**

**CASEMENT WINDOW SERIES**

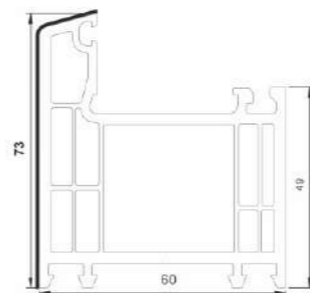

**P60 K(A1)-D, FRAME CASEMENT DOOR (73\*60)**

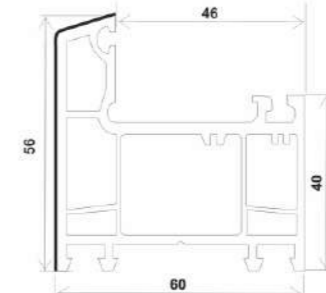

**P60 KD, FRAME CASEMENT WINDOW (60\*58)**

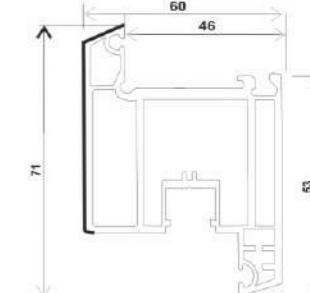

**P60 NKS, SASH WINDOW INWARD (60\*71)**

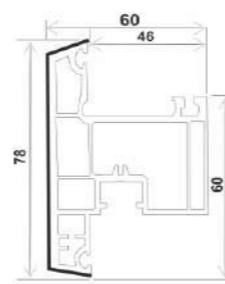

**P60-WKS, SASH WINDOW OUTWARD (60\*78)**

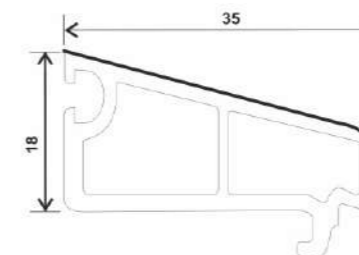

**P60-DY, BEAD CASEMENT SINGLE GLASS (18\*35)**

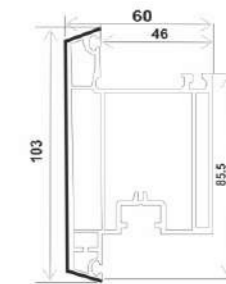

**P60-MS, SASH CASEMENT OUTWARD DOOR (60\*103)**

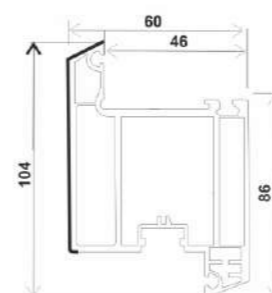

**P60-NKMS, SASH CASEMENT INWARD DOOR (60\*104)**

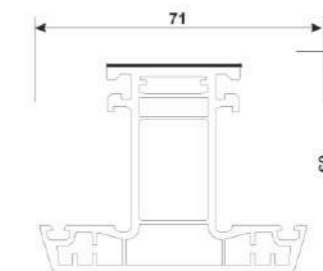

**P60-ZT-D, MULLION T CASEMENT (60\*71)**

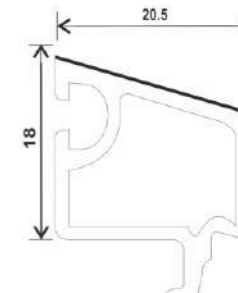

**P60-SY, BEAD DOUBLE GLASS CASEMENT (18\*20.5)**

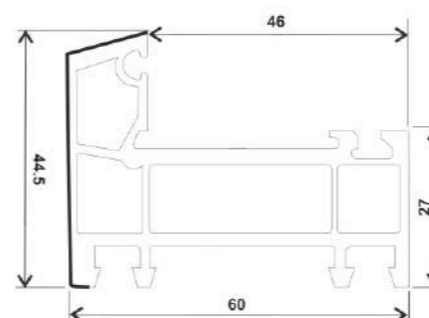

**P60-GDK, FRAME CASEMENT NARROW (60\*44.5)**

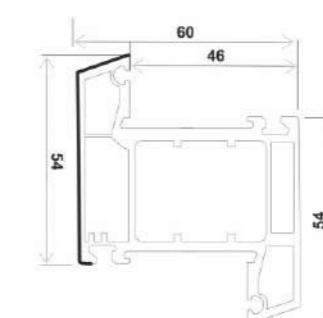

**P60-ZZT(B), MULLION CASEMENT Z**



**P60-FZT(II)-D, MULLION CASEMENT MOVABLE (60\*60)**



# P R F G R O U P

UPGRADE TO QUALITY. CHOOSE PRF UDYOG.



## **RUNNER UP** UPVC PROFILE

**Call us**

**+91 933 093 6298**

**More info**

[prfudyog.alampur@gmail.com](mailto:prfudyog.alampur@gmail.com)



## HARDWARES



Touch Lock



Popup Handle



Cocksper Handle



D Handle Large



Bearing Single Roller



Double Roller



Mesh Roller



Single Roller



Adjustable Roller



3D Hinges



2D Hinges



Hinges Concealed

## HARDWARES



Plastic Bomb Stopper



Plastic U-Packer



Fix Luwar



Glass Packer



Anti Lift Block



Drainage Cap



Luwar Adjustable Blade



Fastner Screw 8x80



T-Lock



Wool Pile



Gasket



Silicon



Casement Clip



Friction Stay

## REINFORCEMENT



## SLIDING 60 SERIES

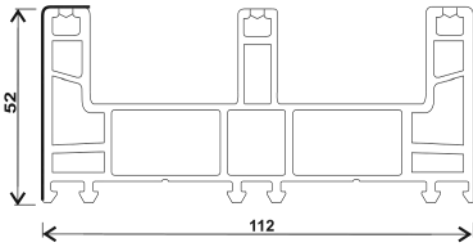

**R T112-K, SLIDING 3 TRACK  
FRAME (112\*52)**  
1.653

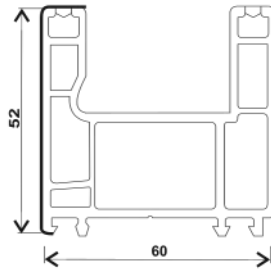

**R T60-KB, SLIDING 2 TRACK  
FRAME (60\*52)**  
1.025

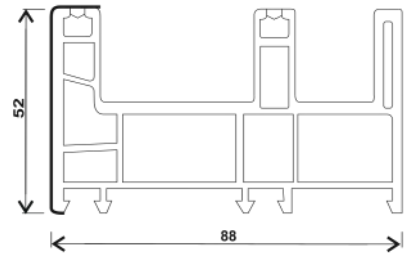

**R T88-PK(J), SLIDING 2.5 TRACK  
FRAME (88\*52)**  
1.322

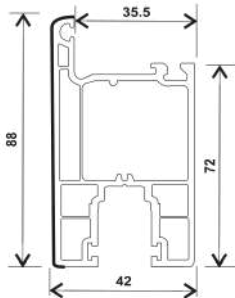

**R T-MS, SLIDING DOOR  
SASH (42\*88)**  
1.193

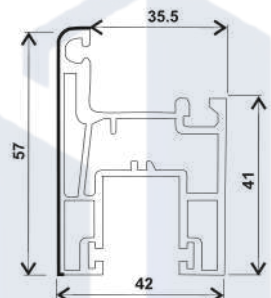

**R T88-S, SASH SLIDING  
WINDOW (42\*57)**  
0.847

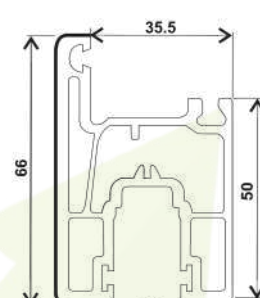

**R T95-S, SASH SLIDING  
WINDOW (42\*66)**  
0.956

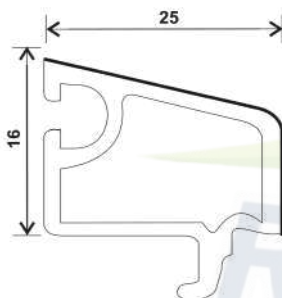

**R T88-DY, SLIDING SINGLE GLASS  
BEAD (16\*25)**  
0.269

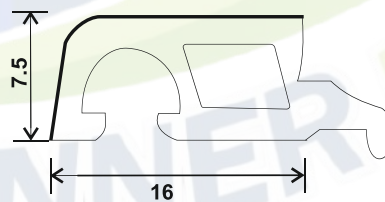

**R T88-SY(I), SLIDING DOUBLE GLASS  
BEAD (SMALL)(16\*7.5)**

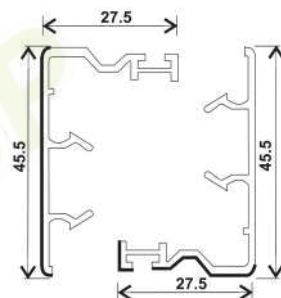

**R T88-FBB(I), INTERLOCK WINDOW  
(27.5\*42.5)**  
0.222

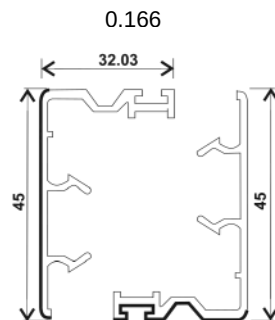

**R T95-FB, INTERLOCK WINDOW  
SASH**  
0.242

## SLIDING 60 SERIES

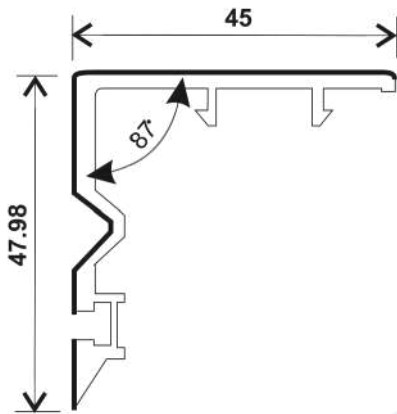

**R T-MFB(1), INTERLOCK DOOR (45\*48)**

0.271

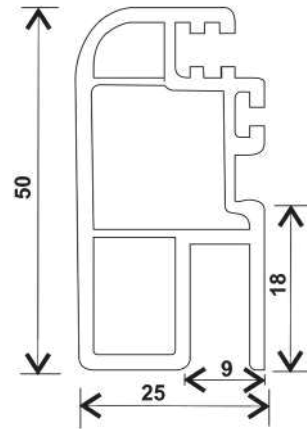

**R T80-BB-DSS, SASH FLY MESH PROFILE**

0.465

## SLIDING ECO SERIES

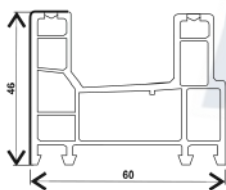

**R CF-T60-LGK, SLIDING 2 TRACK FRAME (60\*46)**

0.939

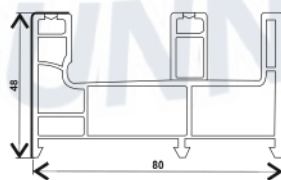

**R CF-T80-PK(I), SLIDING 2.5 TRACK FRAME (80\*48)**

1.176

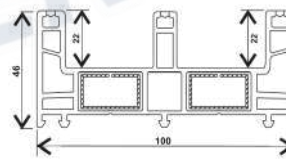

**R T100-K, SLIDING 3 TRACK FRAME (100\*48)**

1.445

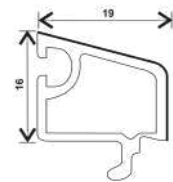

**R T80-DY, SLIDING GLASS BEAD (16\*19)**

0.227

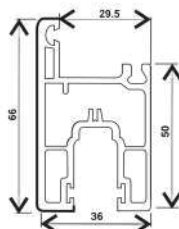

**R T80-DS(I), SASH MONORAIL SLIDING (36\*66)**

0.893

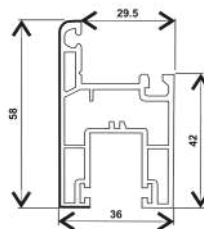

**R CF-T60-S, SASH SLIDING WINDOW (36\*58)**

0.786

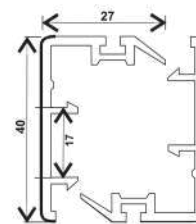

**R T80-FBB(I), INTERLOCK WINDOW (27\*40)**

0.212

## CASEMENT WINDOW SERIES

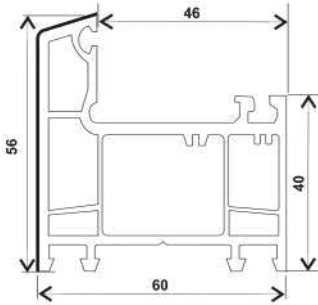

**R P60 KD, FRAME CASEMENT WINDOW (60\*58)**  
1.043

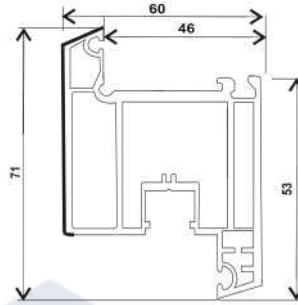

**R P60 NKS, SASH WINDOW INWARD (60\*71)**  
1.260

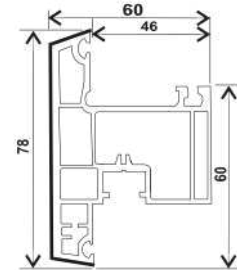

**R P60-WKS, SASH WINDOW OUTWARD (60\*78)**  
1.333

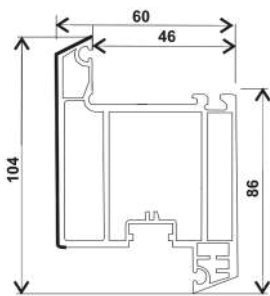

**R P60-NKMS, SASH CASEMENT INWARD DOOR (60\*104)**  
1.560

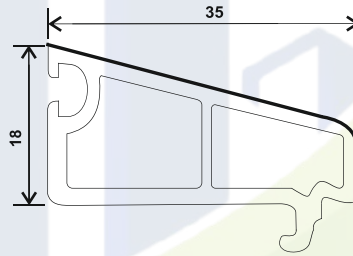

**R P60-DY, BEAD CASEMENT SINGLE GLASS (18\*35)**  
0.324

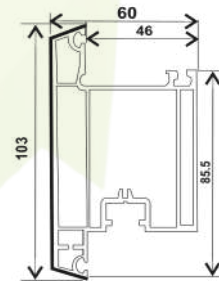

**R P60-MS, SASH CASEMENT OUTWARD DOOR (60\*103)**  
1.580

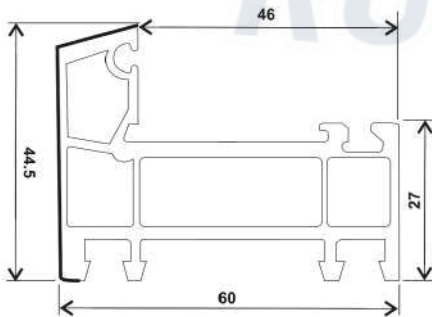

**R P60-GDK, FRAME CASEMENT NARROW (60\*44.5)**  
0.801

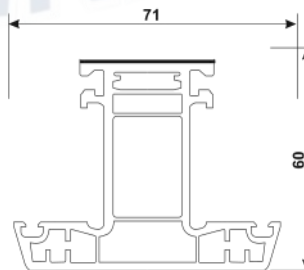

**R P60-ZT-D, MULLION T CASEMENT (60\*71)**  
1.198

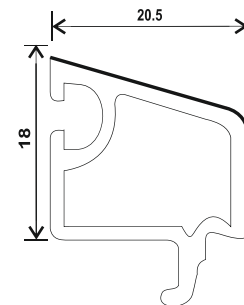

**R P60-SY, BEAD DOUBLE GLASS CASEMENT (18\*20.5)**  
0.233





• P R F G R O U P •

## PUF PANEL AND REINFORCEMENT MANUFACTURING

### PUF ROOFING PANEL



### REINFORCEMENT

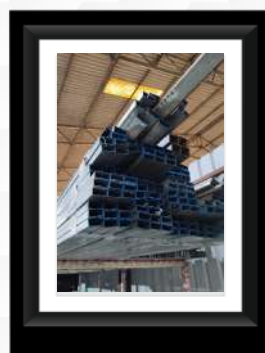



# PRF GROUP

## Our Warehouse

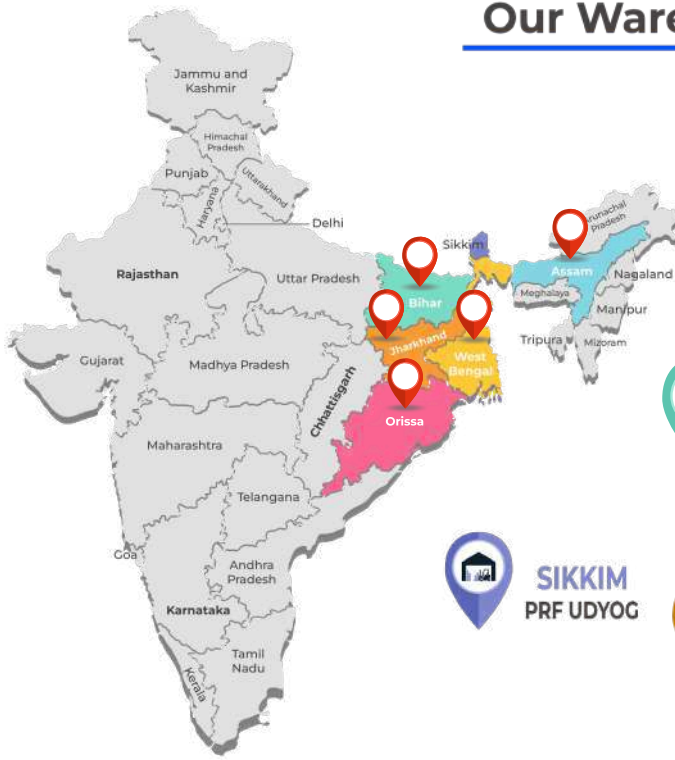

**WEST BENGAL**  
MOTHER WAREHOUSE



**BIHAR**  
PRF UDYOG



**ODISHA**  
PRF UDYOG



**SIKKIM**  
PRF UDYOG



**JHARKHAND**  
PRF UDYOG



**ASSAM (GUWAHATI)**  
PRF UDYOG

## CONTACT US

- +91 933 093 6298 (WB OFFICE)
- +91 810 079 8301 (ASSAM OFFICE)
- +91 810 079 8322 (JHARKHAND OFFICE)
- +919147768780 (ODISHA OFFICE)

prfudyog.alampur@gmail.com

www.prfudyog.com

Follow us @ Prf Udyog Kolkata

Dhulagarh, P.O- Dhulagarh, Sibtala  
(near Ambuja Cement Industry)  
Kolkata, Howrah, Pincode: 711302



SCAN HERE  
TO GET MORE  
INFORMATION

